

DS-220 SERIES

Rating: 0.3A 30V DC

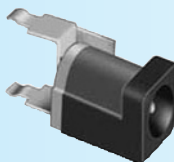

DIA.OF PIN`X` A=2.5 mm
DIA.OF PIN`X` B=2.0 mm
DIA.OF PIN`X` C=2.35 mm

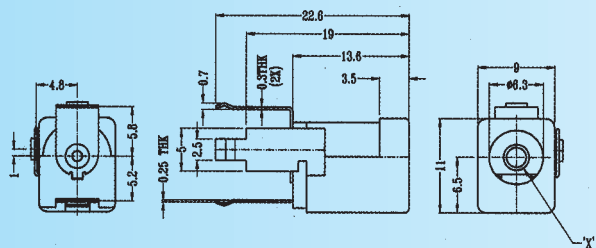
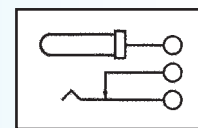

DS-222 SERIES

Rating: 0.3A 30V DC

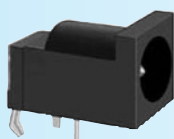
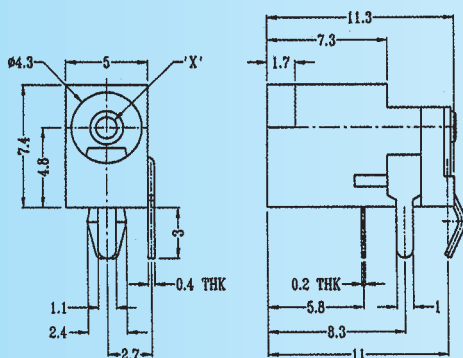

DIA.OF PIN`X` A=1.3 mm
DIA.OF PIN`X` B=1.0 mm
DIA.OF PIN`X` C=1.35 mm

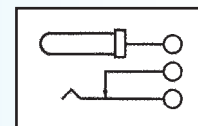

DS-225 SERIES

(PHENOLIC RESIN TERMINAL BASE)

Rating: 0.3A 30V DC

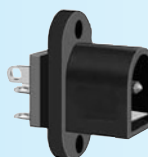
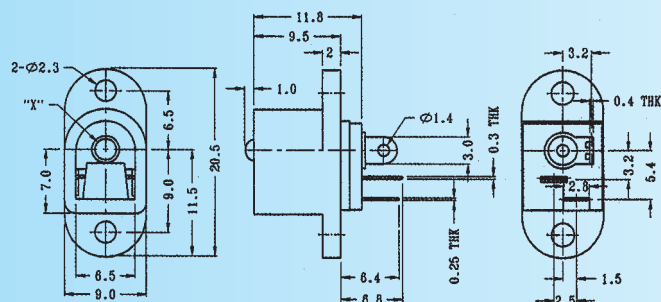

DIA.OF PIN`X` A=2.5 mm
DIA.OF PIN`X` B=2.0 mm
DIA.OF PIN`X` C=2.35 mm

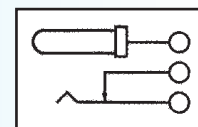

DS-226 SERIES

Rating: 0.3A 30V DC

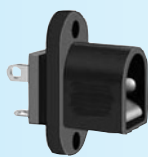
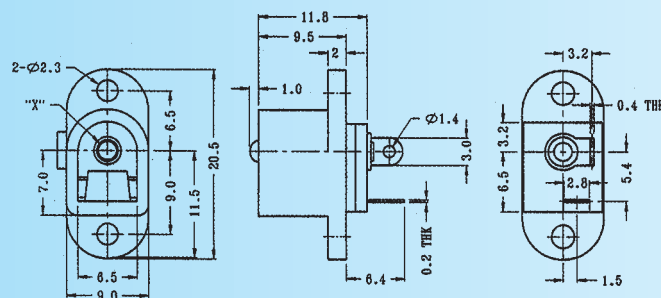

DIA.OF PIN`X` A=2.5 mm
DIA.OF PIN`X` B=2.0 mm
DIA.OF PIN`X` C=2.35 mm

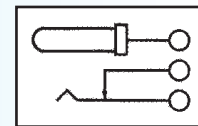

DS-229 SERIES

(PHENOLIC RESIN TERMINAL BASE)

Rating: 0.3A 30V DC

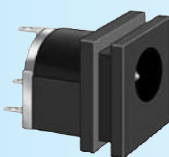
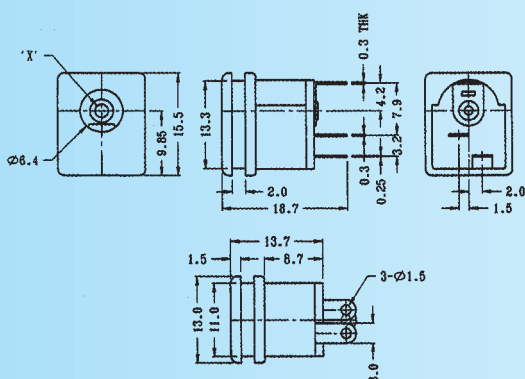

DIA.OF PIN`X` A=2.5 mm
DIA.OF PIN`X` B=2.0 mm
DIA.OF PIN`X` C=2.35 mm
DIA.OF PIN`X` G=3.0 mm

