

## RC-125

Rating: 0.3A 30V DC

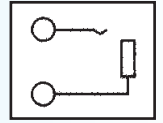
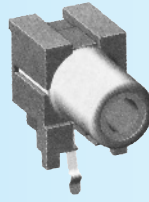
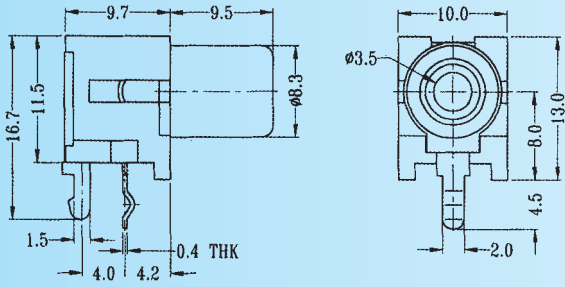

## RC-127

Rating: 0.3A 30V DC

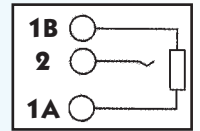
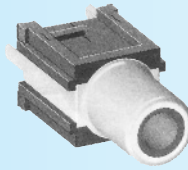
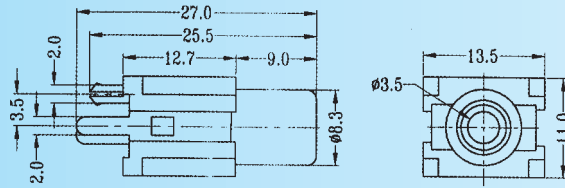

## RC-129

Rating: 0.3A 30V DC

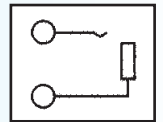
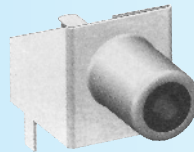
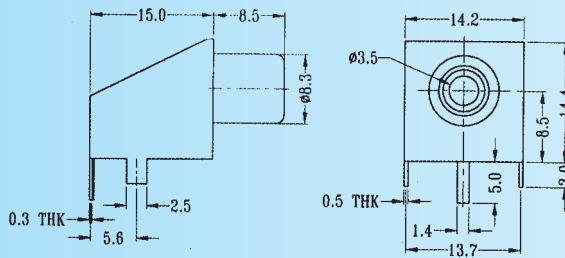

## RC-139

Rating: 0.3A 30V DC

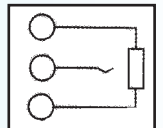
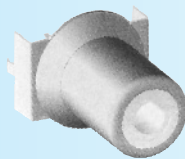
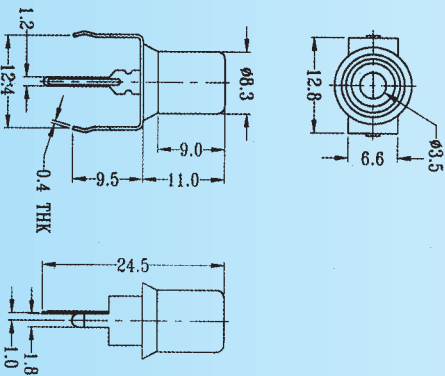

## RC-140

Rating: 0.3A 30V DC

