

## TC-1194 LED TACT SWITCH

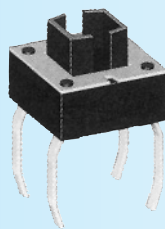

1. RATING: DC 12V 50mA
2. TRAVEL:  $0.25 \pm 0.1$  mm
3. CONTACT RESISTANCE  $100\text{m}\Omega$  MAX
4. OPERATING FORE:  $160 \pm 50\text{gf}$

### CIRCUIT DIAGRAM

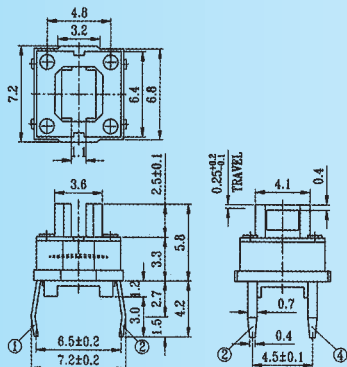
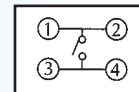

## TC-2401 series

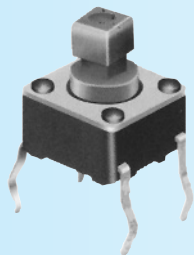
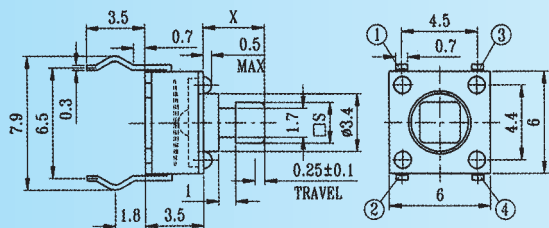

MODEL	Stem Dimension	Stem length, mm
TC-2401	2.4 x 2.4 mm	3.6
TC-2402	2.4 x 2.4 mm	3.9
TC-2801	2.4 x 2.8 mm	3.6

CODE	Operating Force, gf
T	100±30
V	130±30
X	160±50
W	170±50
Y	190±50
Z	250±100

1. RATING: DC 12V 50mA
2. TRAVEL:  $0.25 \pm 0.1$  mm
3. CONTACT RESISTANCE  $100\text{m}\Omega$  MAX

### CIRCUIT DIAGRAM

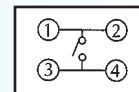

## TC-2412 series

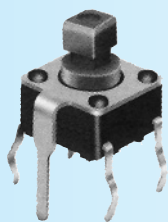
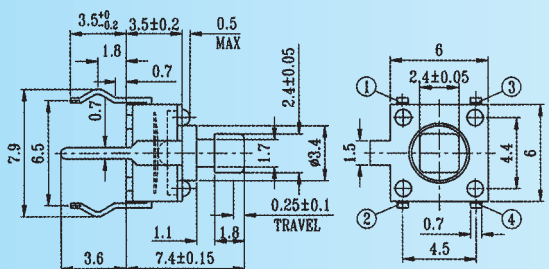

CODE	Operating Force, gf
T	100±30
V	130±30
X	160±50
W	170±50
Y	190±50
Z	250±100
N	350±100
R	500±100

1. RATING: DC 12V 50mA
2. TRAVEL:  $0.25 \pm 0.1$  mm
3. CONTACT RESISTANCE  $100\text{m}\Omega$  MAX
4. STEM DIMENSION 2.4 x 2.4 mm
5. STEM LENGTH 3.6 mm

### CIRCUIT DIAGRAM

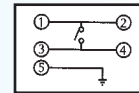

## TC-3120 series

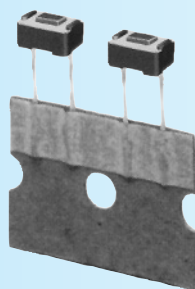
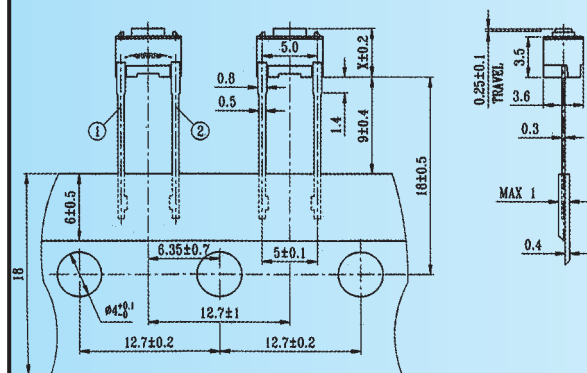

MODEL	Stem length, mm	CODE	Operating Force, gf
TC-3120	4.3	Y	180±50
TC-3121	5	Z	250±50
TC-3122	8		

1. RATING: DC 12V 50mA
2. TRAVEL:  $0.25 \pm 0.1$  mm
3. CONTACT RESISTANCE  $100\text{m}\Omega$  MAX

### CIRCUIT DIAGRAM

